



GEN series CTS600ID

600 A RMS / 900 A DC Current
Transducer

Special features

- 600 A RMS nominal current
- 900 A DC nominal current
- 500 kHz bandwidth (-3 dB)
- 27.6 mm aperture for cables and bus bars
- -40 °C to +85 °C operating range
- Best in class for accuracy and stability
- Isolated AC and DC current measurements
- 3 ppm maximum linearity error
- Industry standard D-SUB 9 connector
- Full aluminum body for superior EMI shielding
- Advanced sensor protection circuits

GEN series CTS600ID applications

The HBM series of current transducers feature industry standard, fluxgate, closed-loop technology. The second harmonic zero flux detection ensures the highest accuracy and lowest drift while maintaining a high bandwidth. HBM current transducers are perfect for measuring currents between 10 and 1000 A RMS. With the high bandwidth support, they can be used with fast rise time signals, such as those found in electric drives or other inverter applications, such as those in renewable industries.

The CT series is available for 50 A RMS to 1200 A RMS, all sharing the same high-end technology. All connectors are compatible for fast exchange.

The optional 1 HE 19" rack mountable power supply can power any mix of up to six CTs. Current output cables to connect directly to the GN31XB power card, as well as to the GN61XB card, are available.

Optional burden resistors are available for the GEN series Data Acquisition Systems or power analyzers without an integrated burden resistor.

The advanced sensor protection circuit ASPC prevents sensor damage for incorrect use cases, such as currents applied to unpowered CTs or powered CTs without a burden resistor to close the current output loop.

Specification Highlights			
	Symbol	Value	Comment
Nominal primary AC current	I_{PN} AC	600 A RMS	
Nominal primary DC current	I_{PN} DC	± 900 A	
Nominal secondary current	I_{SN}	± 600 mA	At nominal primary DC current
Primary / secondary ratio	n1 : n2	1 : 1500	
Measurement range	\hat{I}_{PM}	± 1000 A	
Measurement resistance	R_M	3 Ω maximum	See Figure 1.1 for details
Bandwidth	f(-3dB)	500 kHz	Small signal, refer to Figure 1.3

Electrical Specifications			
At Ta = 23 °C, supply voltage = ± 15 V unless otherwise stated			
Parameter	Symbol	Value	Comment
Overload capacity	\hat{I}_{OL}	± 4500 A for 100 ms	Non-measured, 100 ms
Linearity error	ϵ_L	± 1 ppm	Refers to nominal DC current
Offset current (including earth field)	I_{OE}	± 8.33 ppm	Refers to nominal DC current
DC -10 Hz overall accuracy @ 25 °C (= $\epsilon_L + I_{OE}$)	acc ϵ	± 9.33 ppm	Refers to nominal DC current
Offset temperature coefficient	TC I_{OE}	± 0.1 ppm/K	Refers to nominal DC current
Amplitude error	ϵ_G	10 Hz - 2 kHz	$\pm 0.01\%$
		2 kHz - 10 kHz	$\pm 0.20\%$
		10 kHz - 100 kHz	$\pm 2.50\%$
Phase shift	θ	10 Hz - 2 kHz	$\pm 0.03^\circ$
		2 kHz - 10 kHz	$\pm 0.04^\circ$
		10 kHz - 100 kHz	$\pm 1.00^\circ$
Response time to a step current IPN	tr @ 90%	1 μ s	di/dt = 100A/ μ s
Noise	noise	0 - 100 Hz	0.01 ppm RMS
		0 - 1 kHz	0.02 ppm RMS
		0 - 10 kHz	0.2 ppm RMS
		0 - 100 kHz	0.7 ppm RMS
Fluxgate excitation frequency	f_{Exc}	32.5 kHz	
Induced RMS voltage on primary conductor		5 μ V RMS	
Stability			
Offset stability over time		± 0.1 ppm/month	Refers to nominal DC current
Offset change with vertical external magnetic field		± 0.8 μ A /mT (± 0.2 μ A /mT typical)	(Perpendicular to bus bar) μ A refers to secondary current
Offset change with horizontal external magnetic field		± 2 μ A /mT (± 0.8 μ A /mT typical)	(Perpendicular to bus bar) μ A refers to secondary current
Offset change with power supply voltage changes		± 0.04 μ A /V (± 0.004 μ A /V typical)	μ A refers to secondary current
Offset change with absolute power supply voltages tracking		\pm TBD μ A /V	μ A refers to secondary current
Power supply			
Power supply voltages	Uc	15 V \pm 0.75 V DC	
Positive current consumption	Ips	104 mA + Is	Add Is (if Is is positive)
Negative current consumption	I _{ns}	96 mA + Is	Add Is (if Is is negative)

Burden Resistor RM and Ambient Temperature Derating

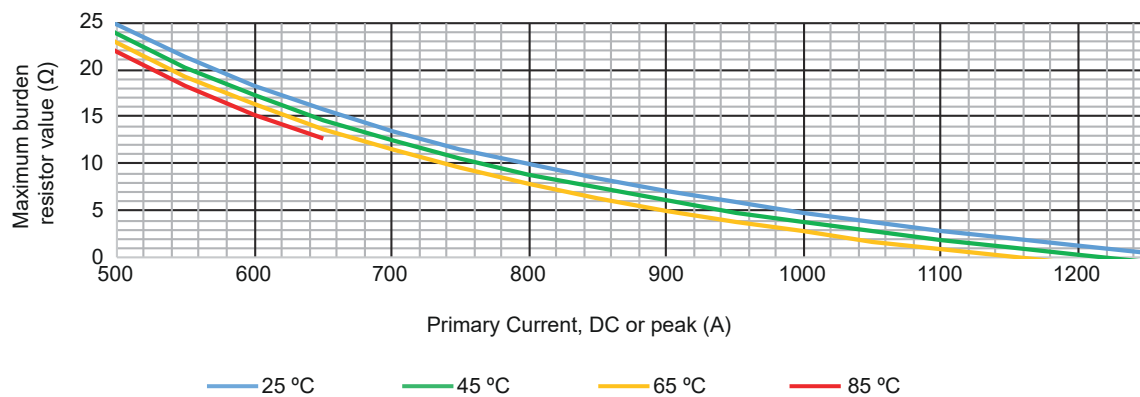

Figure 1.1: Burden resistor RM and ambient temperature derating

Frequency and Ambient Temperature Derating

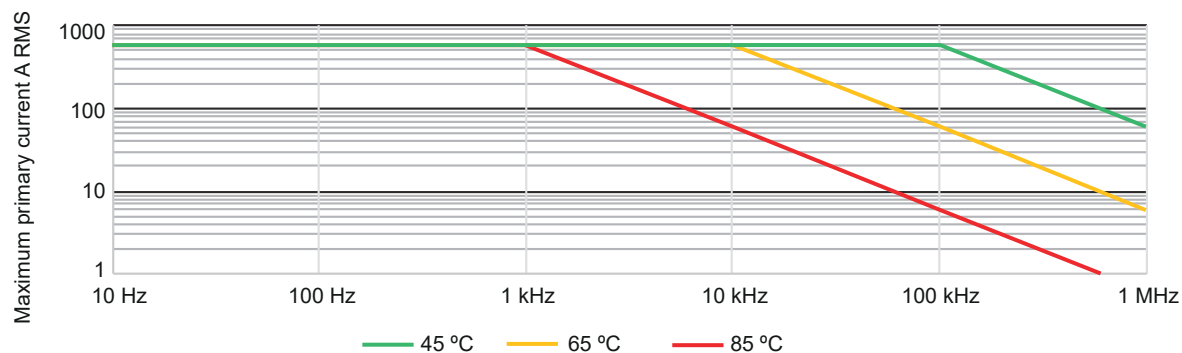

Figure 1.2: Frequency and ambient temperature derating

Amplitude and Phase Frequency Characteristics

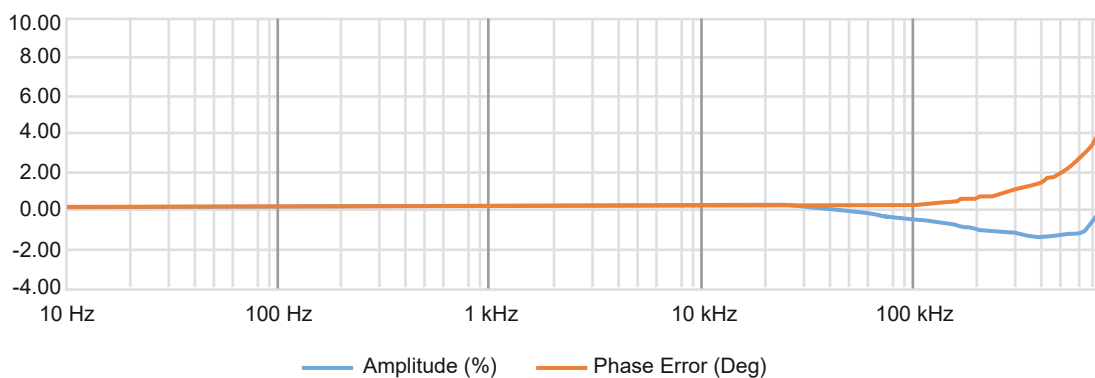

Figure 1.3: Frequency characteristics

Isolation Specifications		
Clearance	9 mm	
Creepage distance	10 mm	
Comparative tracking index (CTI)	> 600 V	
RMS voltage for AC isolation test, 50/60 Hz, 1 min		
Between primary and (secondary and shield)	5.7 kV	
Between secondary and shield	0.2 kV	
Impulse withstand voltage (1.2/50 μ s)	10.4 kV	
Continuous working voltage	Using uninsulated wire	Using insulated wire
Non mains signals	1000 V	2000 V
CAT II signals	600 V RMS / 600 V DC	1000 V RMS / 1000 V DC
CAT III signals	300 V RMS / 300 V DC	1000 V RMS / 1000 V DC
Transient voltage	Using uninsulated wire	Using insulated wire
Non mains signals	4500 V	6000 V
CAT II signals	6000 V	6000 V
CAT III signals	6000 V	8000 V

Note Higher isolation voltages can be achieved using isolated bus bars. Contact custom systems at: customsystems@hbm.com.

Environmental and Safety Specifications	
Ambient operating temperature range	-40 °C to +85 °C
Storage temperature range	-40 °C to +85 °C
Relative humidity	20% to 80%, Non-condensing
Maximum altitude	2000 m (6562 ft)
Harmonized standards for CE compliance	EN 61326-1 EMC EN 61010-1:2010 Safety IEC61010-2-30
External devices	External devices connected to current transducers must comply with the standards IEC61010-1, IEC60950 or IEC62368-1 and be energy-limited circuitry
Cleaning	The transducer should only be cleaned with a damp cloth. No detergent or chemicals should be used.
Ambient Temperature	Note: When multiple primary turns are used or high primary currents are applied the temperature around the transducer will increase, please monitor to ensure that the maximum ratings are not exceeded. It is recommended to have minimum 1mm ² per ampere in the primary bus-bar.

Advanced Sensor Protection Circuits (ASPC)
Developed to protect the current transducer from typical fault conditions
<ul style="list-style-type: none"> Unit is unpowered and secondary circuit is open or closed Unit is powered and secondary circuit is open or interrupted
Both DC and AC primary current up to 100% of nominal value can be applied to the current transducers in the situations above without damage to the electronics

Note The sensor core can be magnetized in all the cases above, resulting in a small change in output offset current (less than 10 ppm)

Korean Certification	
	상호 : 스펙트리스코리아주식회사
	기자재명칭(모델명) : 1-CTS600ID/Current transducer (CTS600ID)
	제조사 : Hottinger Brüel & Kjaer GmbH, Germany
	제조국가 : 덴마크
	R-R-s3k- CTS600ID

D-SUB 9 Pins Male Pin Layout

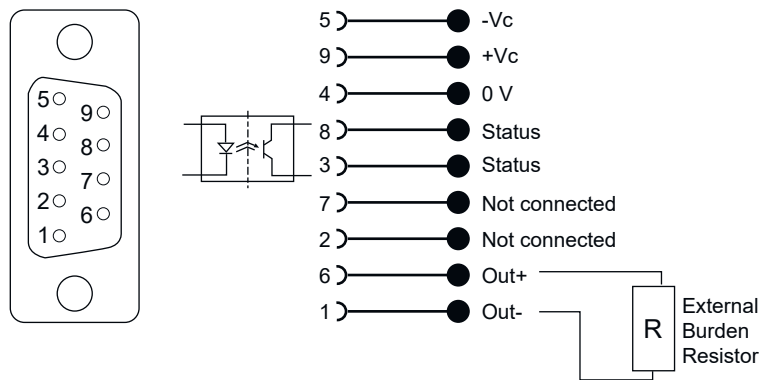

Figure 1.4: Standard D-SUB 9 current output

Status pin properties

Forwarded direction	Pin 8 to 3 (shorted, when the sensor is operating in normal conditions)
Maximum forward current	10 mA
Maximum forward voltage	60 V
Maximum reverse voltage	5 V
Positive primary current direction	Identified by an arrow on the transducer body

Physical, Weight and Dimensions⁽¹⁾

Weight	0.6 kg
Mounting instructions	
Base plate mounting	2 holes Φ 6.5 mm 2 x M5 steel screws / 6 N.m
Back side panel mounting	3 holes Φ 4.0 mm x 6 H 3 x M4 steel screw / 4 N.m

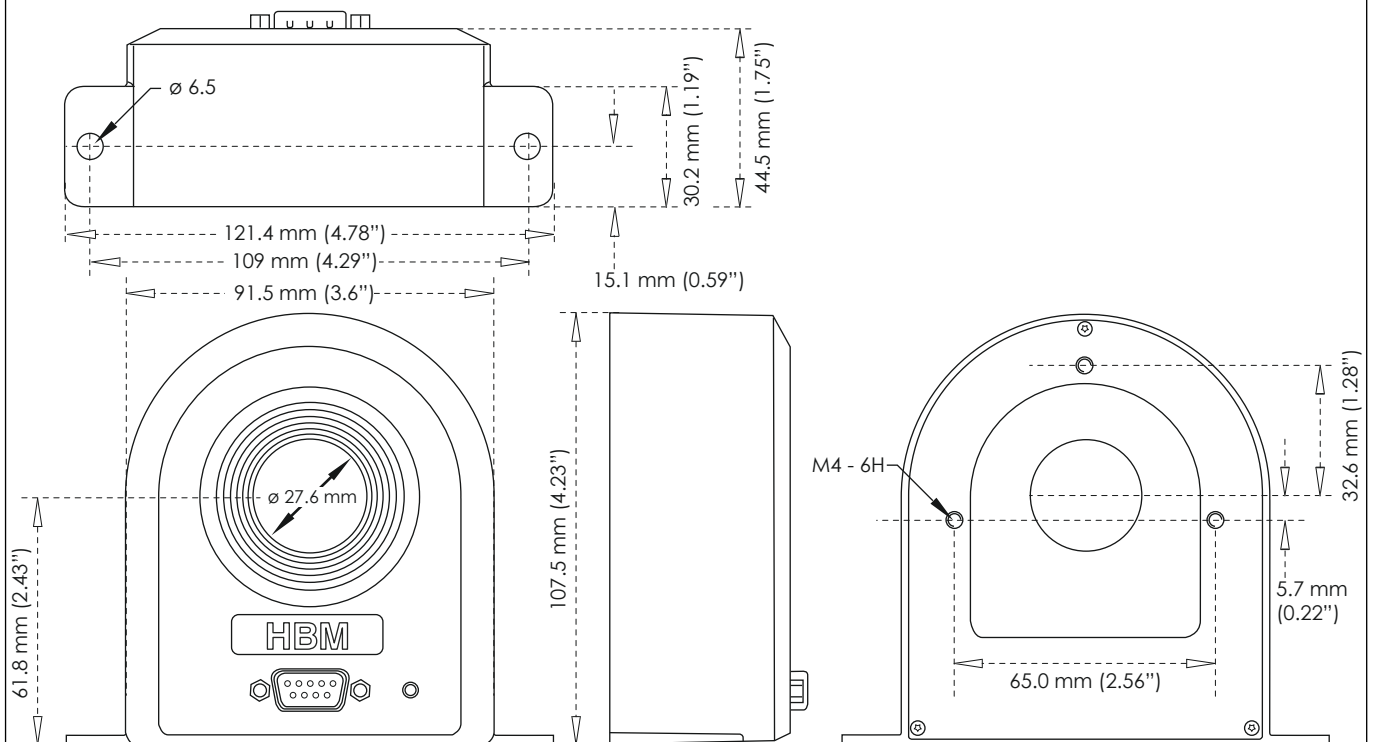

Figure 1.5: CTS50/200ID/400ID/600ID dimensions

(1) General tolerance of 0.3 mm unless otherwise stated

1-CTPSIU-6-1U Interface Unit for CT (Option, to be ordered separately)

Modular 19" rack with 1 to maximum 6 channel CT support.



Figure 1.6: Front side (left) and rear side (right)

Maximum number of CTs	6
Input connectors	9 pin SUBD
Output connectors	XLR
Signal LEDs	CT Power ON, CT Status
Power supply	100 to 240 V AC, 47 to 63 Hz 120 - 370 V DC
Weight	Typical 6.5 kg (14.33 lb)
Operating temperature range	0 °C to +50 °C (32 °F to 122 °F)
Dimensions	
Height	87.2 mm (3,43")
Width / Width including mounting ears	442 mm (17,40") / 466 mm (18,34")
Depth	415 mm (16,33")

Figure 1.7: Dimensions

Current Transducer Family Overview

Type	Nominal current	Bandwidth (-3 dB)	Ratio Primary : Secondary	Aperture size
CTS50ID	50 A RMS / 75 A DC	1000 kHz	1 : 500	27.6 mm
CTS200ID	200 A RMS / 300 A DC	500 kHz	1 : 500	27.6 mm
CTS400ID	400 A RMS / 600 A DC	300 kHz	1 : 2000	27.6 mm
CTS600ID	600 A RMS / 900 A DC	500 kHz	1 : 1500	27.6 mm
CTM1200ID	1200 A RMS / 1500 A DC	400 kHz	1 : 1500	45.0 mm
CTM1200ID-CD3000 ⁽¹⁾	1200 A RMS / 1500 A DC	15 kHz	1 : 1500	45.0 mm

Other values available on request⁽²⁾

- (1) Support for low current calibration.
 (2) Contact custom systems at: customsystems@hbm.com
 Request quote/information for special products for GEN series.

GN310B/GN311B HBM Current Transducer (CT) Wire Diagram

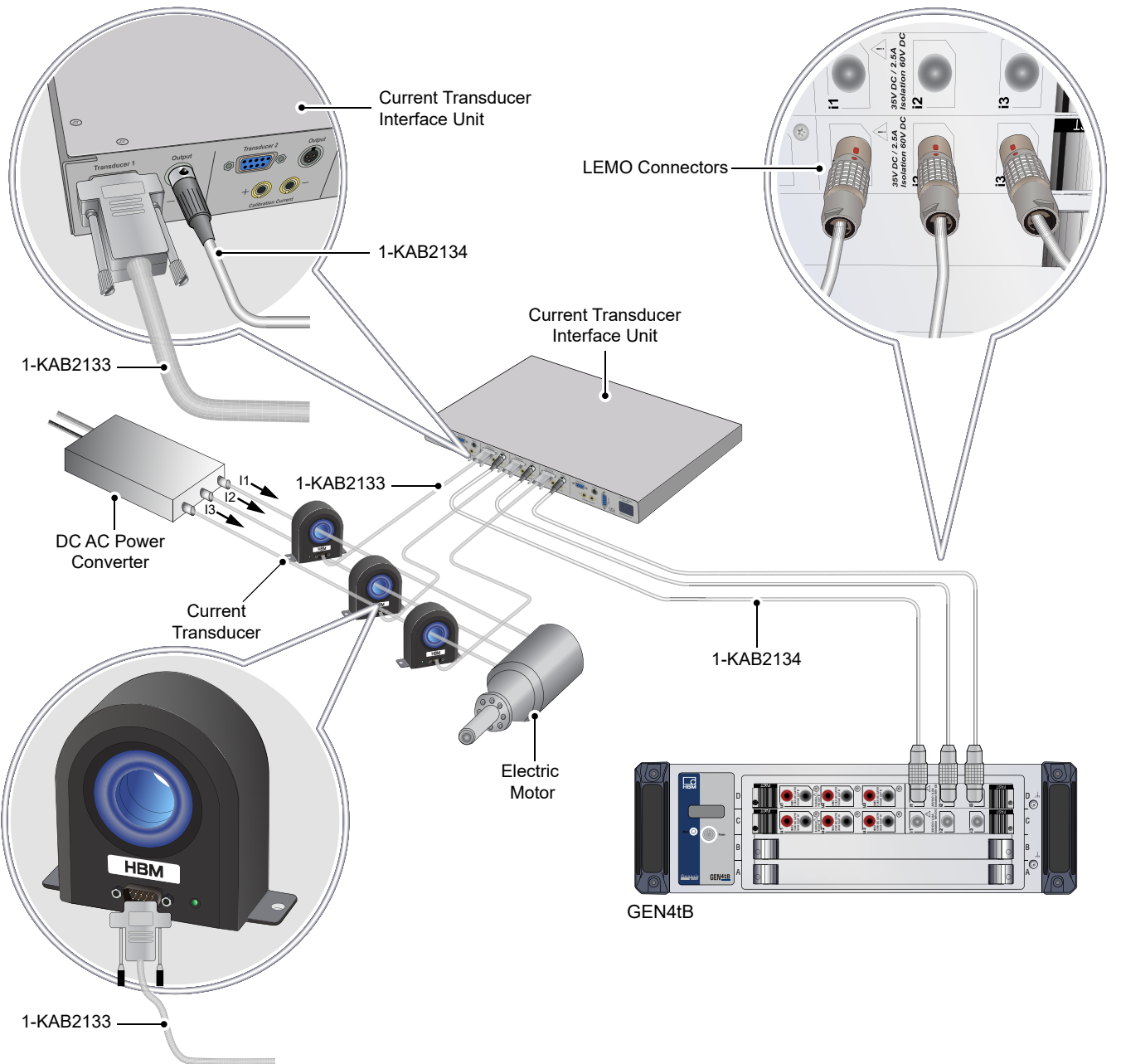

Figure 1.8: Current transducer connection diagram

GN610B/GN611B Current Transducer (CT) Wire Diagram

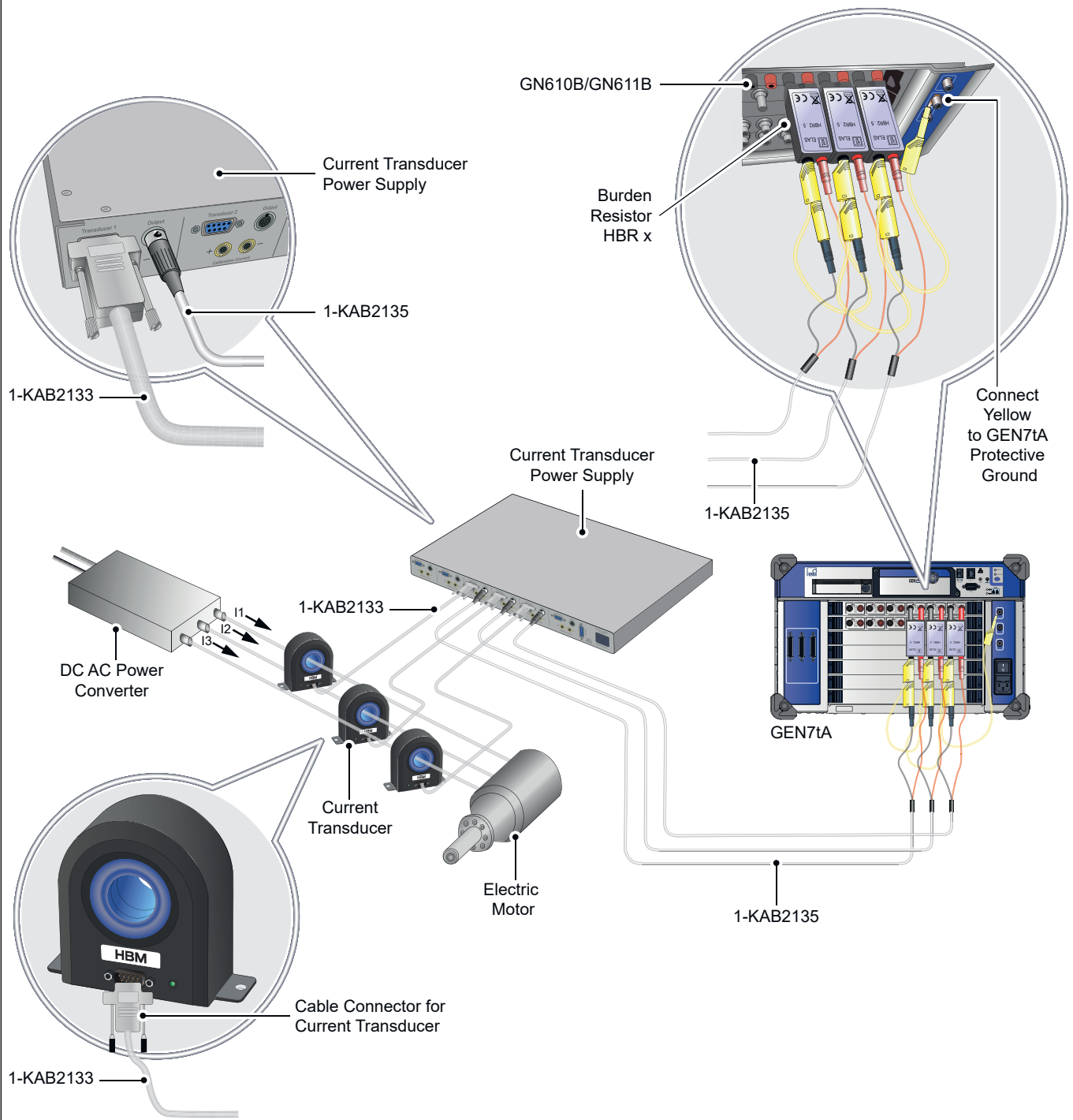







Figure 1.9: Current transducer connection diagram

Ordering Information

Article	Description	Order No.
900 A DC or 600 A RMS current transducer 	Ultra-stable, high-precision fluxgate technology current transducer. Non-intrusive isolated DC and AC current measurements up to 600 A RMS / 900 A DC. Full aluminum body for superior EMI shielding. Extended operating temperature range. Large aperture \varnothing 27.6 mm for cables and bus bars. Industry standard D-Sub 9 pin connection.	1-CTS600ID

Current Transducers Interface and Cables, to be ordered separately





Article	Description	Order No.
CT Interface unit 	Interface unit for up to six current transducers. Industry standard D-SUB 9 pin input connectors. Multi-pin XLR output connectors. Supports transducer calibration winding access through 4 mm banana plugs. Front LEDs to indicate normal operation of each transducer. 100 - 240 V AC 50/60 Hz AC input voltage. 120 - 370 V DC input voltage. 1U height 19" rack mountable.	1-CTPSIU-6-1U
CT cables 	Industry standard current transducer connection cable. Shielded, low ohmic 9 wire cable with D-SUB 9 connectors on both ends. Supports power, status, current output and calibration current input. Lengths: 2, 5, 10 and 20 meters (6, 16, 32 and 65 ft)	1-KAB2133-2 1-KAB2133-5 1-KAB2133-10 1-KAB2133-15 1-KAB2133-20
XLR to LEMO cable for GN31XB 	CT interface unit to GN31xB DAQ power card connection cable. Uses XLR and LEMO connectors for a direct current output connection to the GEN DAQ card. Length 2 m (6 ft)	1-KAB2134-2
XLR to Banana cable for GN61XB 	CT interface unit to GN61xB DAQ 1kV card connection cable. Uses XLR and banana connectors for a current output connection to the GEN DAQ card. Requires an additional burden resistor in front of the GN61xB card to convert current to voltage. Length 2 m (6 ft)	1-KAB2135-2

GN610B/GN611B Burden Resistors, to be ordered separately

Burden selection for GN610B/GN611B

Note: When using the CTS/CTM series together with GN610B/GN611B cards a burden resistor is required to convert the CT output current to a voltage. When selecting the burden several specifications need to be taken into account: maximum power of the burden, maximum voltage the CT can drive with constant current, the wire impedance of the cables used etc. See the CT operating manual for more details.

Model	Recommended burden	mV/A sensitivity	A/V scaling
CTS50ID	HBR 2.5 Ω	5.0	200
CTS200ID	HBR 1.0 Ω	2.0	500
CTS400ID	HBR 1.0 Ω	0.5	2000
CTS600ID	HBR 1.0 Ω	0.6667	1500
CTS1200ID	HBR 1.0 Ω	0.6667	1500
CTS1200ID-CD3000	HBR 1.0 Ω	0.6667	1500

Article	Description	Order No.
HBR 0.25 Ω, 1 W precision burden resistor 	0.25 Ω 1 W, 0.02% high precision, low thermal drift burden resistor. Internally uses 4 wire connection to reduce inaccuracy caused by the currents running to the burden resistor. Using banana input connectors and banana output pins. Directly compatible with GN610B/GN611B acquisition cards.	Ordered from custom systems ⁽¹⁾
HBR 0.5 Ω, 1 W precision burden resistor 	0.5 Ω 1 W, 0.02% high precision, low thermal drift burden resistor. Internally uses 4 wire connection to reduce inaccuracy caused by the currents running to the burden resistor. Using banana input connectors and banana output pins. Directly compatible with GN610B/GN611B acquisition cards.	Ordered from custom systems ⁽¹⁾
HBR 1 Ω, 1 W precision burden resistor 	1 Ω, 1 W, 0.02% high precision, low thermal drift burden resistor. Internally uses 4 wire connection to reduce inaccuracy caused by the currents running to the burden resistor. Using banana input connectors and banana output pins. Directly compatible with GN610B/GN611B acquisition cards.	Ordered from custom systems ⁽¹⁾
HBR 2.5 Ω, 1 W precision burden resistor 	2.5 Ω, 1 W, 0.02% high precision, low thermal drift burden resistor. Internally uses 4 wire connection to reduce inaccuracy caused by the currents running to the burden resistor. Using banana input connectors and banana output pins. Directly compatible with GN610B/GN611B acquisition cards.	Ordered from custom systems ⁽¹⁾
HBR 10 Ω, 1 W precision burden resistor 	10 Ω, 1 W, 0.02% high precision, low thermal drift burden resistor. Internally uses 4 wire connection to reduce inaccuracy caused by the currents running to the burden resistor. Using banana input connectors and banana output pins. Directly compatible with GN610B/GN611B acquisition cards.	Ordered from custom systems ⁽¹⁾

(1) Contact custom systems at: customsystems@hbm.com
Request quote/information for special products for GEN series.

©Hottinger Brüel & Kjaer GmbH. All rights reserved.
All details describe our products in general form only.
They are not to be understood as express warranty and do
not constitute any liability whatsoever.

Hottinger Brüel & Kjaer GmbH

Im Tiefen See 45 · 64293 Darmstadt · Germany
Tel. +49 6151 803-0 · Fax: +49 6151 803-9100
E-mail: info@hbm.com · www.hbm.com

measure and predict with confidence

